

INSTALLATION INSTRUCTIONS

Model 400 DGC

MEDIUM CONVOLUTED DIAPHRAGM INSTRUMENTS DIFFERENTIAL PRESSURE INSTRUMENT



Ambit Instruments Pty Ltd.

42 Titan Drive, Carrum Downs

Victoria 3201, Australia

Phone : +61 3 9776 8888

Fax : +61 3 9776 8656

Email : contact@ambitinst.com.au

website : www.ambitinst.com.au

For efficient working of your instrument, please read all instructions carefully before attempting to install.

CAUTION : Do not exceed maximum operating pressure given on the instrument label.

Check fluid compatibility with wetted parts before use.

OPERATING PRINCIPLE

High and Low pressures are separated by a sensor assembly consisting of a magnet, diaphragm and a range spring. The difference in pressure causes the sensor assembly to move in proportion to the change against a range spring.

A rotary magnet, located in a separate body compartment and isolated from the acting pressures, is rotated by magnetic coupling as per the linear movement of the sensor assembly. A pointer attached to the rotary magnet indicates differential pressure on the dial.

SWITCH : Reed switches are located adjacent to the pressure chamber and are activated by the magnetic field of the sensor assembly.

Note : The instruments are calibrated to give $\pm 2\%$ full scale accuracy on ascending readings.

INSTALLATION

For better performance the instrument should be mounted horizontally by keeping the dial vertical.

Depressurize the system and connect the high and low pressure lines of your system to the "High" \oplus & "Low" \ominus ports of the instrument, respectively.

It is recommended to use "O" rings with male connectors to avoid excessive tightening and to prevent leakage (For parallel threads). The instrument is now ready for operation.

Apply "High" and "Low" pressures simultaneously, to avoid damage to the internal parts.

Model 400 DGC consists of a convoluted diaphragm to sense the pressure difference. It can withstand maximum operating pressure up to 100 bar for all ranges. If pressure exceeds the rated maximum pressure, "O" rings & diaphragm inside the pressure chamber, will be damaged. If maximum operating pressure is within the allowable limit of 100 bar, but the differential pressure exceeds instrument range, there will be no damage to the instrument. Pointer will only go the extreme right end of the scale.

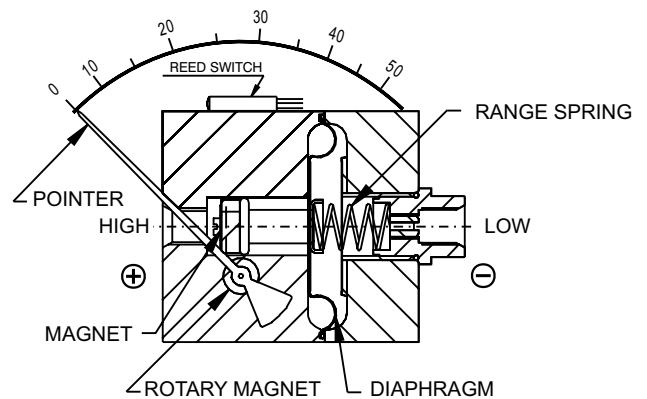

PRECAUTIONS

Do not connect "High" and "Low" ports to wrong pipe ends. Do not subject the instrument to excessive vibration.

The instrument is never to be used in an area where a magnetic field is present. It may show wrong readings.

As the instrument works on magnetic coupling, use only non magnetic fittings, parts etc. in areas closer than 50 mm on all sides, otherwise calibration will get effected. Panel mounted instruments should be installed in non-ferrous panel material.

Do not try to open any part of the instrument for any reason, because if not reassembled properly calibration will be affected.

SWITCH SETTING (400 DGC)

Please follow these instructions when your differential pressure instruments are supplied with switch. The switches are normally factory set to save time at customer's end. However they are field adjustable.

CAUTION : Supply should not exceed switch rating. For higher supply, use of relay circuit is recommended.

SWITCH ADJUSTMENT

Switch adjustment screw is located on plastic cover.

Rotate the screw anti-clockwise to increase the set point and clockwise to decrease the set point.

One or two trials may be necessary to attain the exact set point.

Above procedure to be followed by putting the instrument on test bed or while in actual service.

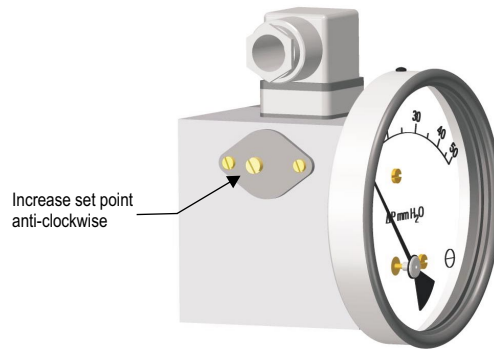

View from high pressure side

SPST SWITCH

Specifications

Contact Rating : 10 VA AC (rms) or DC (max)
 Switching Current : 0.5 Amp AC (rms) or DC (max)
 Switch Voltage : 150 V AC (rms) or DC (max)

One SPST switch

Reed switches & Din plug connection

View of socket for supply connections

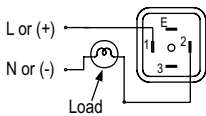

View of plug after removing the socket

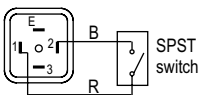

Two SPST switches

Reed switches & Din plug connection

View of socket for supply connections

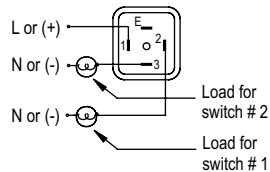

View of plug after removing the socket

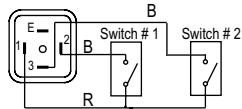

SPDT SWITCH

Specifications

Contact Rating : 5 VA AC (rms) or DC (max)
 Switching Current : 0.25 Amp AC (rms) or DC (max)
 Switch Voltage : 175 V AC (rms) or DC (max)

One SPDT switch

Reed switches & Din plug connection

View of socket for supply connections

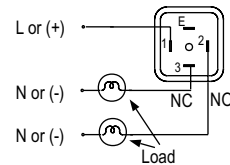

View of plug after removing the socket

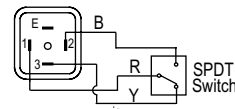

R=Red, B=Black, Y=Yellow, L=Live or +ve supply, N=Nutral or -ve supply
 * Body to be suitably earthed while using gauge + switch.